

INV-PSE96

INV-PSE48

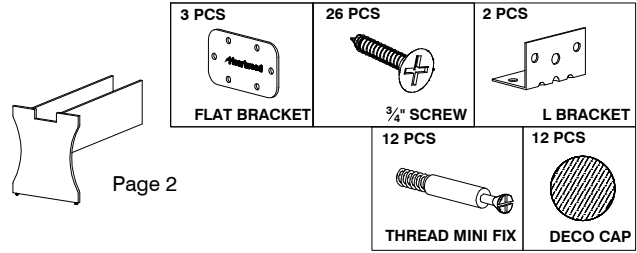
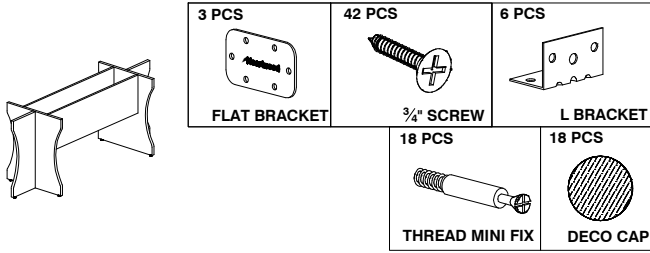

Page 2

INV-RTE9648

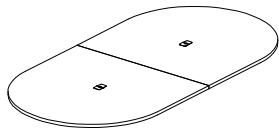

CAUTION:

OFFICE FURNITURE IS HEAVY. ENSURE THAT YOU HAVE ADEQUATE ASSISTANCE WHEN LIFTING AND MOVING PARTS AND ASSEMBLIES. KEEP HARDWARE OUT OF REACH OF CHILDREN.

INV-SQ48

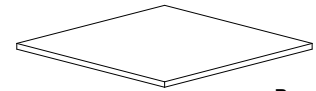

Page 2

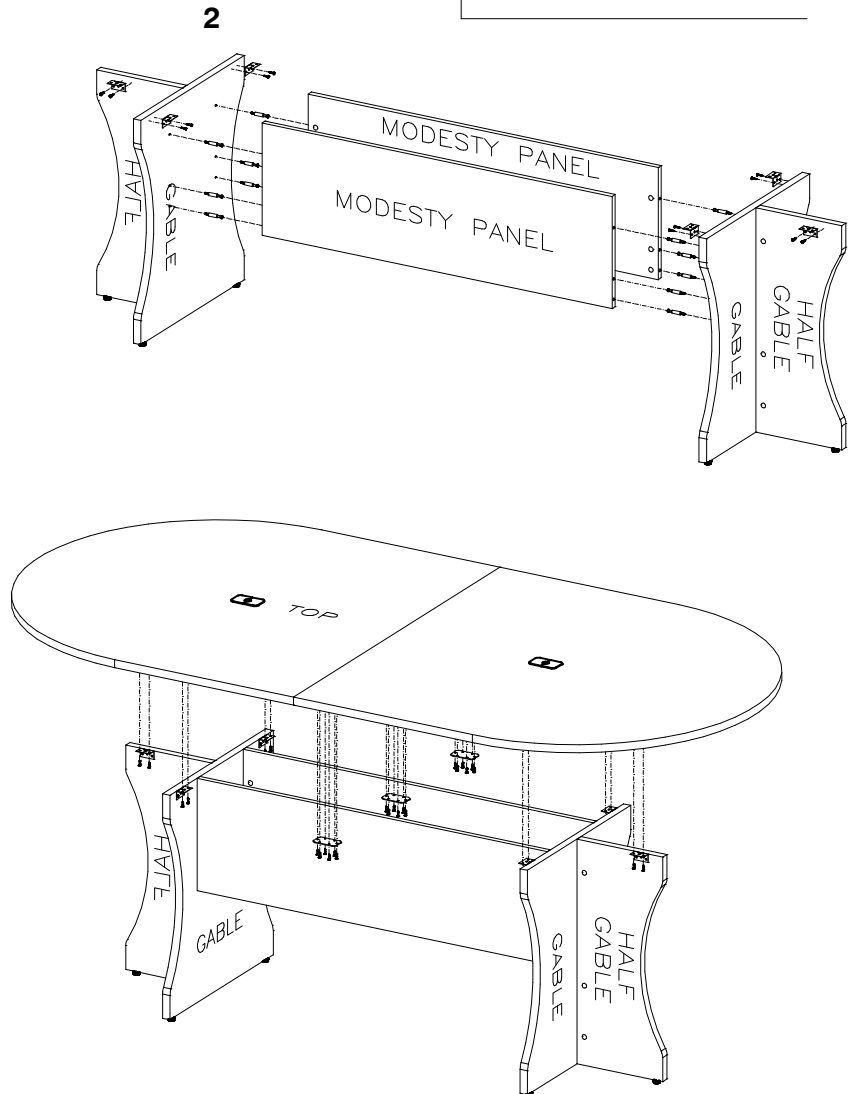
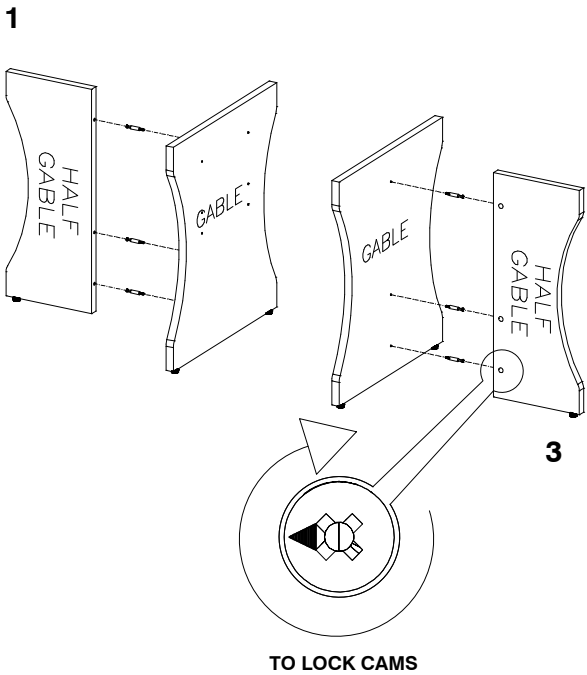

QUESTIONS OR CONCERNS ?
 PHONE Customer Service
 1-866-567-3060
 M-F 6am - 4:30 pm PST

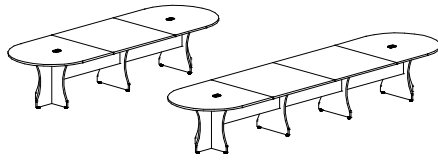

2

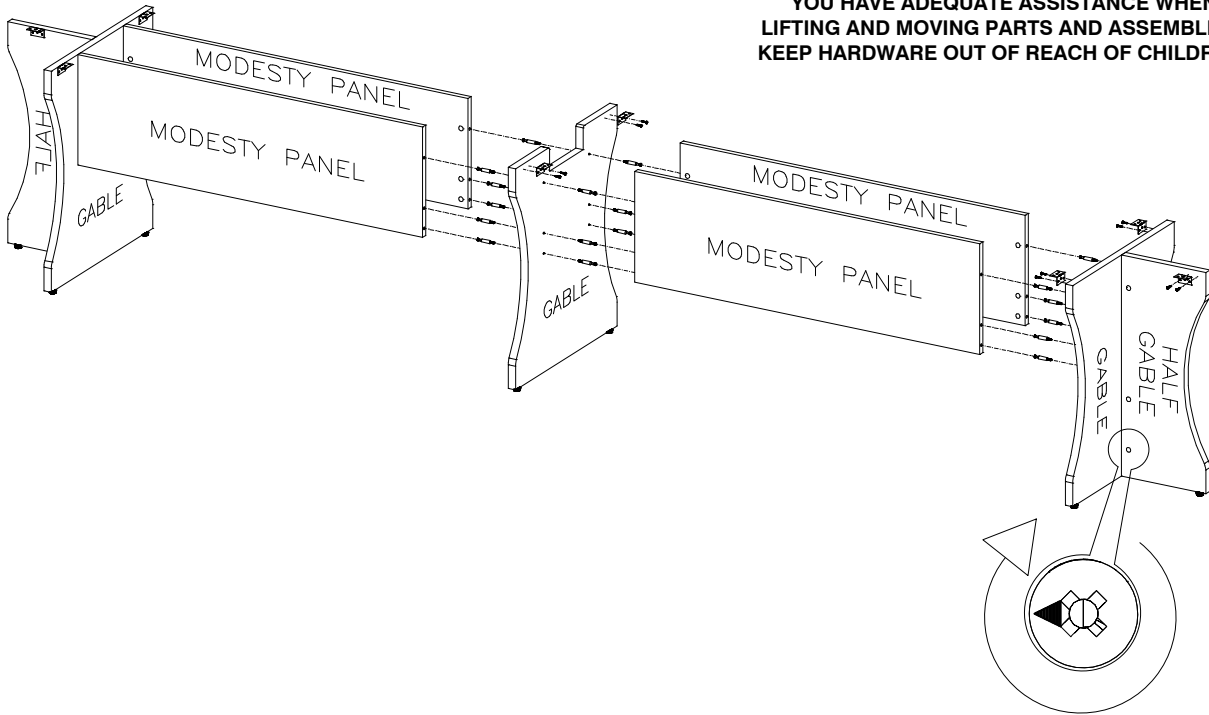

CAUTION:
 OFFICE FURNITURE IS HEAVY. ENSURE THAT YOU HAVE ADEQUATE ASSISTANCE WHEN LIFTING AND MOVING PARTS AND ASSEMBLIES. KEEP HARDWARE OUT OF REACH OF CHILDREN.

TO LOCK CAMS

3

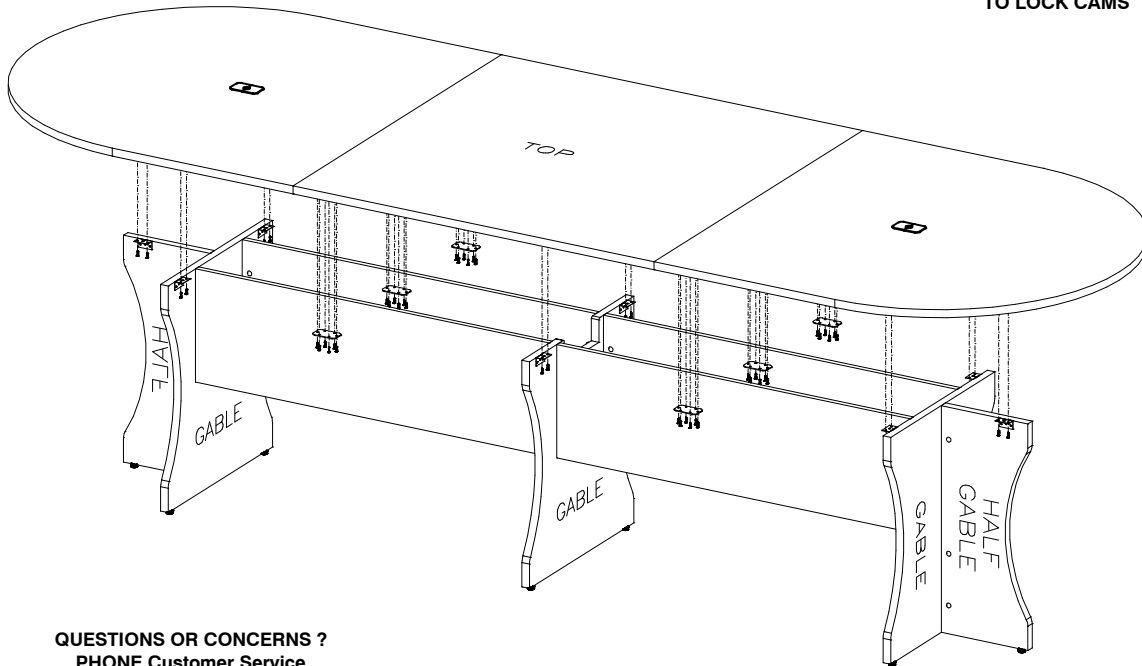

QUESTIONS OR CONCERNS ?
 PHONE Customer Service
 1-866-567-3060
 M-F 6am - 4:30 pm PST



INV-PSE96

INV-PSE48

3 PIÈCES PLAQUES D'AFFLEUREMENT	42 PIÈCES VIS DE 19mm	6 PIÈCES PLAQUE EN "L"
	18 PIÈCES GOUJONS	18 PIÈCES CACHE-VIS

3 PIÈCES PLAQUES D'AFFLEUREMENT	26 PIÈCES VIS DE 19mm	2 PIÈCES PLAQUE EN "L"
	12 PIÈCES GOUJONS	12 PIÈCES CACHE-VIS

Page 2

INV-RTE9648

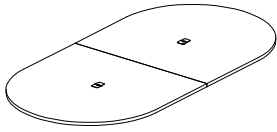

ATTENTION :

**CET ARTICLE D'AMEUBLEMENT EST LOURD.
ASSUREZ-VOUS D'AVOIR L'AIDE NÉCESSAIRE POUR
LE SOULEVER OU EN DÉPLACER LES COMPOSANTS
ET MODULES. GARDEZ LA QUINCAILLERIE HORS DE
LA PORTÉE DES ENFANTS.**

INV-SQ48

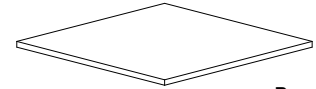

Page 2

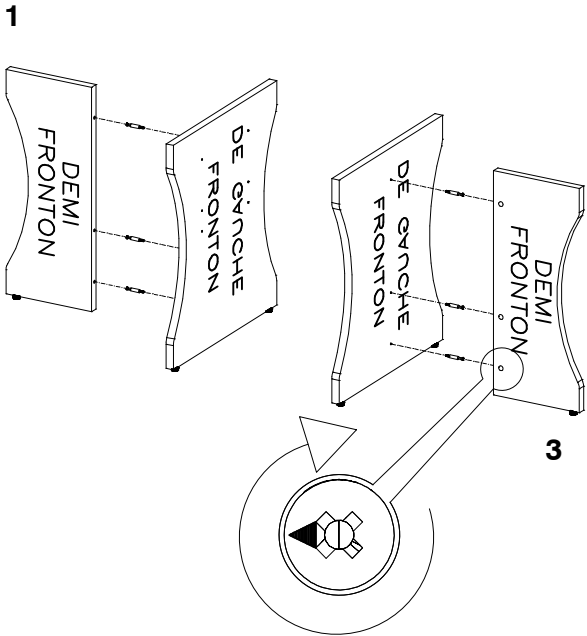

POUR SERRER LES EXCENTRIQUES

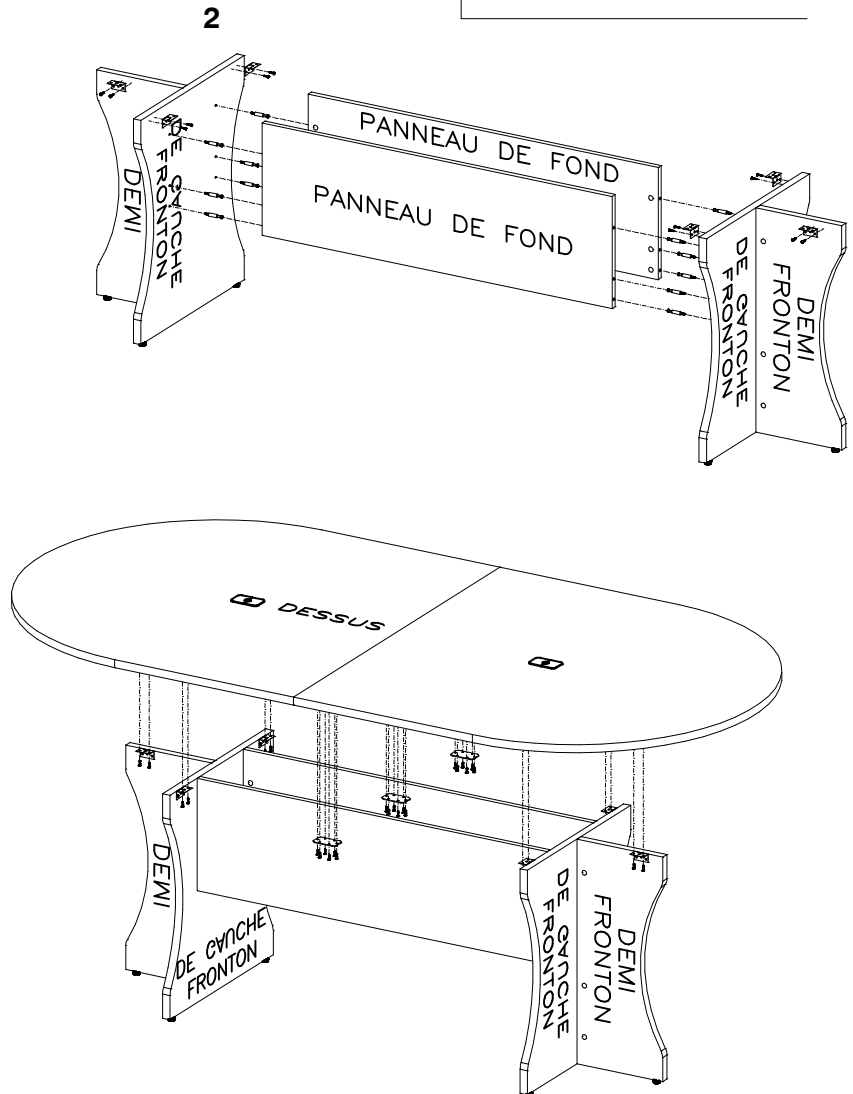

**QUESTIONS OU PRÉOCCUPATIONS ?
COMMUNIQUEZ avec le Service à la clientèle au
1-800-567-3060
du lundi au vendredi de 6 h à 16 h 30 HNP**

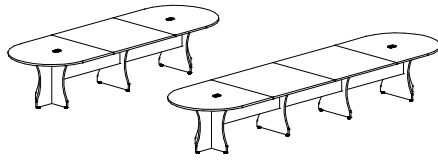

2

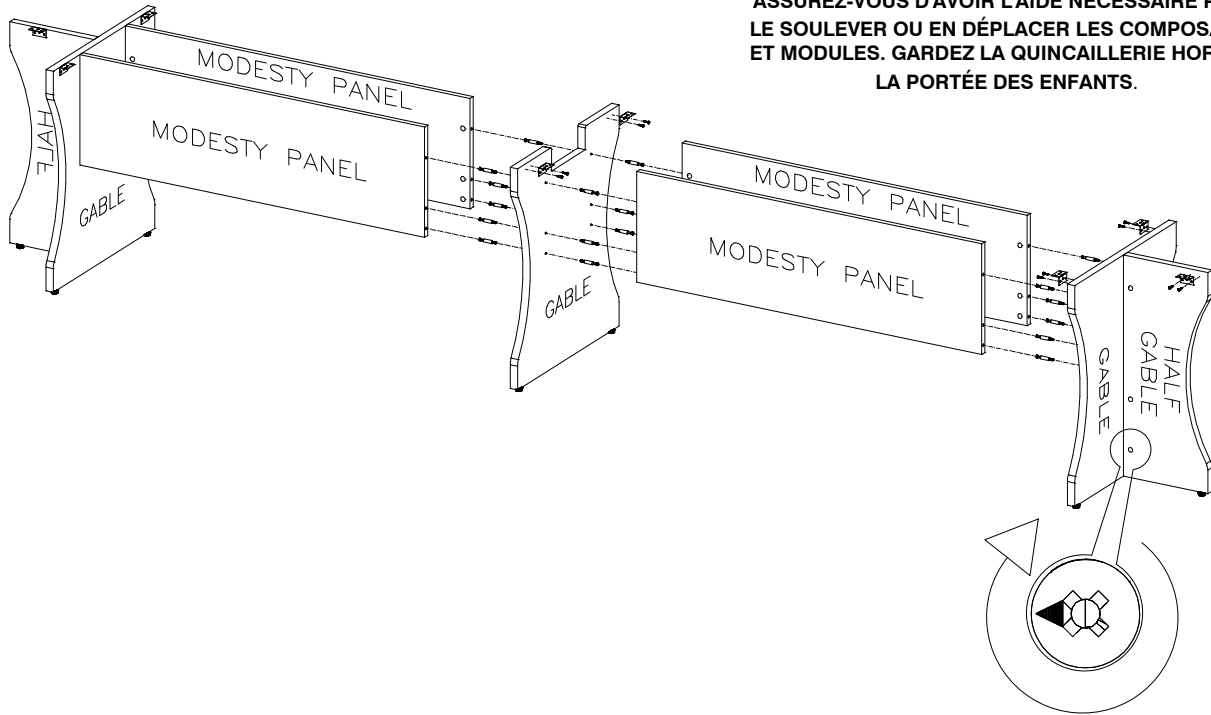

ATTENTION :

**CET ARTICLE D'AMEUBLEMENT EST LOURD.
ASSUREZ-VOUS D'AVOIR L'AIDE NÉCESSAIRE POUR
LE SOULEVER OU EN DÉPLACER LES COMPOSANTS
ET MODULES. GARDEZ LA QUINCAILLERIE HORS DE
LA PORTÉE DES ENFANTS.**

POUR SERRER LES EXCENTRIQUES

3

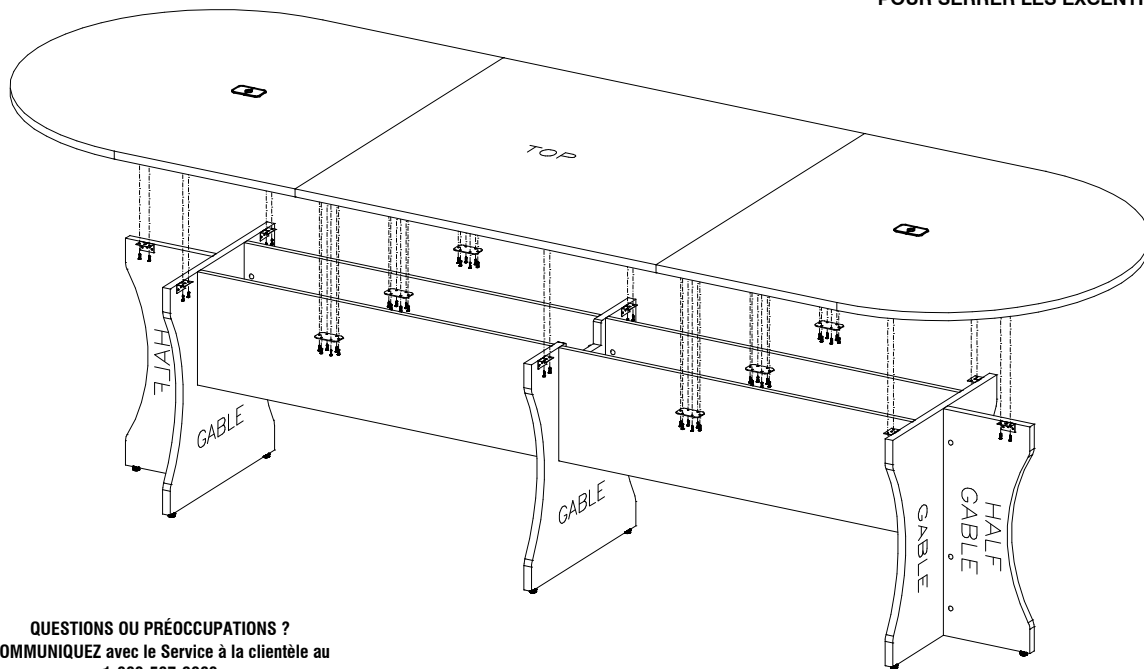

QUESTIONS OU PRÉOCCUPATIONS ?
COMMUNIQUEZ avec le Service à la clientèle au
1-800-567-3060
du lundi au vendredi de 6 h à 16 h 30 HNP