

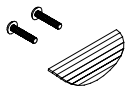



<p>2 PCS 3 PCS</p>  <p>HANDLE & SCREWS</p>	<p>2 PCS</p>  <p>LOCKING PLATE CASTOR</p>	<p>2 PCS</p>  <p>PLATE CASTOR</p>	<p>16 PCS</p>  <p>16mm CB SCREWS</p>	<p>1 PC</p>  <p>STEM CASTOR</p>	<p>1 PC</p>  <p>PENCIL TRAY</p>
--	---	---	--	---	---

1 - CHECK THAT PENCIL TRAY IS IN PLACE.

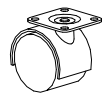

CAUTION:

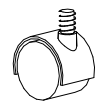
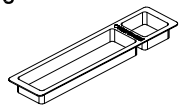
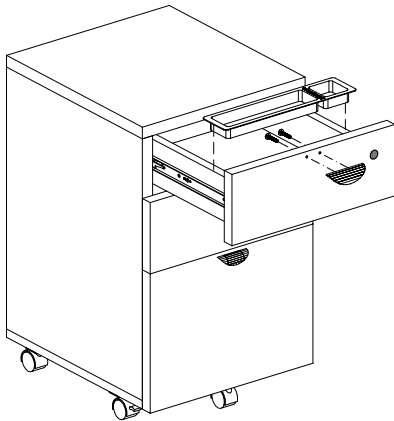
OFFICE FURNITURE IS HEAVY. ENSURE THAT YOU HAVE ADEQUATE ASSISTANCE WHEN LIFTING AND MOVING PARTS AND ASSEMBLIES. KEEP HARDWARE OUT OF REACH OF CHILDREN.

**QUESTIONS OR CONCERNS ?
PHONE Customer Service
1-866-567-3060
M-F 6am - 4:30 pm PST**

2 - INSTALL CASTORS.

